

THE SEPTIC PROFESSIONALS



TARGETED BACTERIAL SOLUTIONS

CONSUMER PRODUCT CATALOG

SPECIALIZED BACTERIA THAT **TARGET** EACH AREA OF THE SYSTEM.

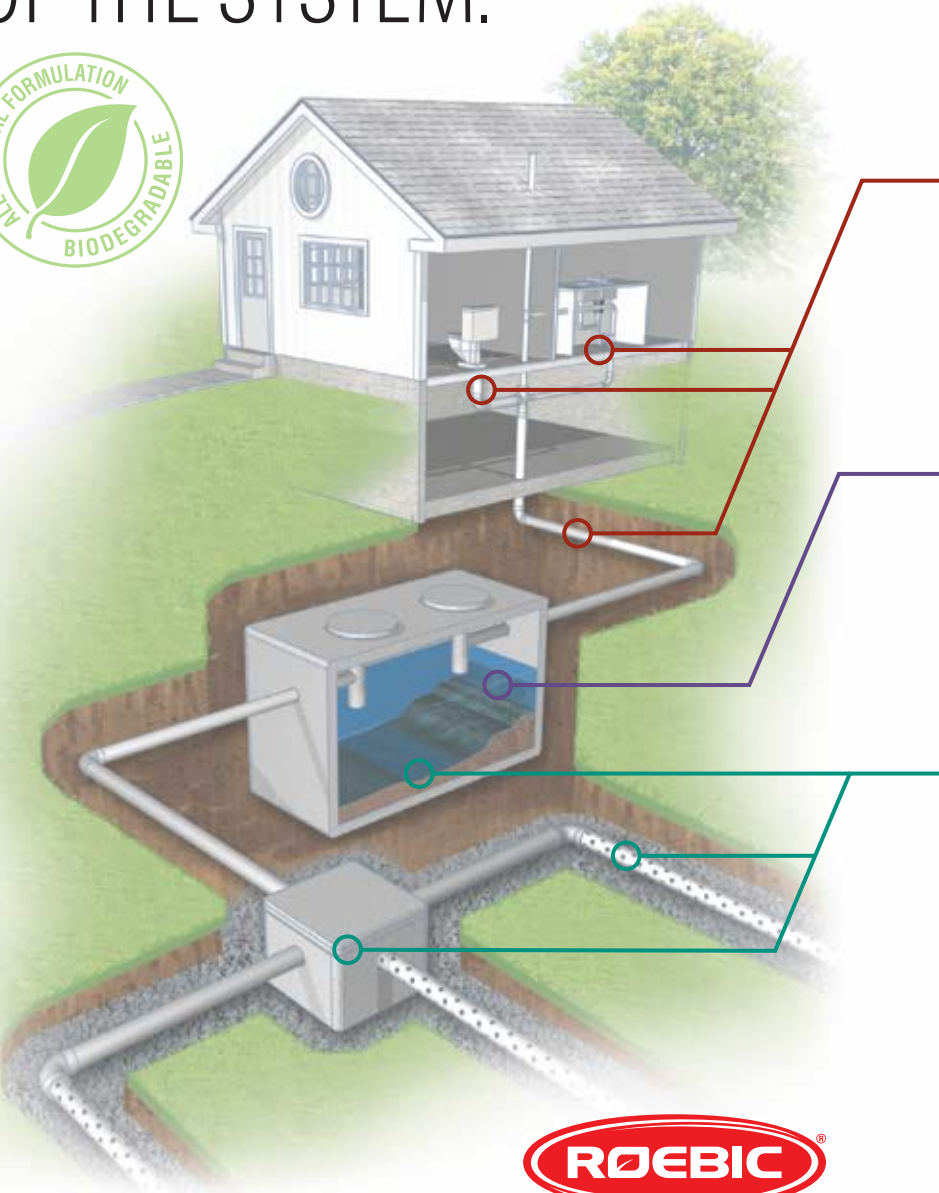

Unique challenges and problems occur within every part of a system. Roebic's patented bacteria resolve these issues by attacking each problem at their source.

Main Lines, Sewer Lines, Drains & Traps

Organic build-up in sewer lines, main lines, drains, and traps can lead to slow drainage, or if left untreated; will cause clogs and messy back-ups. Our powerful, yet non-corrosive, bacterial based drain cleaning products are specifically designed to target sludge and other organic debris deposited in these areas and to keep all drains, traps, sewer and main lines running freely. **K-67 & K-97**

Septic Tanks, Cesspools, & Aerated Treatment Units

In a properly functioning system, these structures are where solids and other septic wastes are broken down and treated. However, this process can be easily thrown out of balance by the use of toxic household chemicals, cleaners, pharmaceutical remnants, or even by excessive water use. Roebic's tank treatment products contain our patented bacterial cultures which promote the rapid breakdown of solids, help keep tanks open and flowing, and aid in overall system efficiency. **K-37, K-47, AOP**

Drainfields, Leachfields, Lateral lines, Infiltrators, & Seepage Pits

Sluggish or clogged drainfields are the primary reason for septic system failure. Failure can be indicated by messy back-ups or by "black water" accumulating in the yard over the drainfield areas. Failed systems are unsightly, odorous, and can be dangerous health hazards. Proper maintenance of these system components is crucial and easy with Roebic's powerful maintenance products. For emergency situations, Roebic's K-57 will quickly clear the clog and restore the flow. **K-570, K-57**

Specialty Treatments

Roebic's scientists have also formulated additional bacterial products to target other specific household waste water issues. Our K-87 S.G.P. degrades difficult organic materials like soap, grease, and paper throughout the entire system. For the elimination of organic build-up in garbage disposals and related plumbing, use K-27 Garbage Disposal Cleaner and Deodorizer. **K-27, K-87**

Drain Openers and Root Killers are also available. **PDO, HD-CRY, K-77, FRK**



FOR OVER 50 YEARS

Roebic Laboratories, Inc. was founded in 1959 in New Haven, Connecticut with the goal of providing the customer with environmentally friendly products that improve plumbing and sewage disposal system performance without the use of dangerous or toxic chemicals. Renowned for its high quality and effective bacterial based products, Roebic Laboratories, Inc. is in the unique position of being the only primary producer of bacterial cultures that also manufactures, formulates and offers their own brand of products for the professional, waste water, and home treatment markets.



PATENTED ROETECH TECHNOLOGY

Throughout the years, we have excelled at formulating waste water treatment products with combinations of ingredients and bacteria strains that are the result of detailed technical analysis and study. The selection of bacterial strains in our products is based on careful consideration of the job at hand, the environment in which they are to be used, and on our vast knowledge of each strain's genetic and enzymatic capabilities. Roebic bacteria are the backbone of our technology and act as the base for our biological formulations in which they perform critical product functions.

OUR BACTERIA	PATENT #'s
<i>Bacillus amyloliquefaciens</i>	6,171,848
<i>Bacillus amyloliquefaciens</i>	6,174,847
<i>Bacillus macerans</i>	6,174,718
<i>Bacillus macerans</i>	6,177,012
<i>Bacillus pumilus</i>	6,083,737
<i>Bacillus subtilis</i>	6,140,106
<i>Bacillus subtilis</i>	6,162,634
<i>Bacillus subtilis</i>	6,162,635



Now in powerful concentrated formulas!

Roebic, the leaders in waste treatment solutions, now offers our most popular products in new concentrated formulations. These formulations provide the same all natural benefits consumers have come to trust, with added convenience for treating today's larger systems.



Concentrated products also carry environmental benefits. These products produce a smaller carbon footprint due to the use of less plastic and other packaging materials per product unit, require less fuel consumption during shipping, and contain less materials for disposal.



QUARTERLY MAINTENANCE SYSTEM (SMP)

Roebic's quarterly treatment program is engineered to keep septic systems operating at peak efficiency. Septic systems can encounter occasional over use or be abused with an influx of cleaners, toxic drain openers, soap, grease and excessive paper use. Each of which can put a burden on a septic systems performance, and lead to a failure.

Our recommended maintenance program was scientifically developed to treat the leading problems that cause a majority of septic system failures. Roebic's maintenance program, combined with regularly scheduled pumping can help septic systems remain trouble free. Roebic, the trusted professionals in bacterial solutions for all septic system needs.



STEP 1
(month 1)



STEP 2
(month 4)



STEP 3
(month 7)



STEP 4
(month 10)

Bacterial Solutions

Roebic provides targeted bacterial solutions for the entire septic system. Our patented technology allows us to formulate bacterial products specifically designed for optimum performance in the micro-environments encountered in waste treatment systems of all sizes.

For more information about our complete line of bacterial products, visit our website today!

www.roebic.com





K-37 SEPTIC TANK TREATMENT

Biological activity in septic tanks is easily thrown out of balance when excessive water, harmful detergents or other harmful chemicals enter the system. K-37 Septic Tank Treatment is specifically designed to restore the natural balance within septic tanks by promoting the efficient and rapid breakdown of solids, thereby reducing sludge and scum levels and resulting in reduced odors, less clogs and more efficient system operation.

AVAILABLE:
SEPTIC TANK TREATMENTS

Quart	- Treats 500 Gallons
Half Gallon	- Treats 1000 Gallons
Quart Concentrate	- Treats 1500 Gallons
Granular Concentrate	- Treats 1500 Gallons

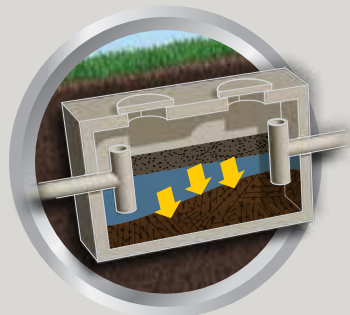



INTRODUCING!

K-570 LEACH & DRAIN FIELD OPENER

Introducing Leach & Drain Field Opener, a product targeting the primary cause for septic system failures, clogged leach and drain fields.

Our new K-570 formulation builds on the success of our K-57. With K-570 we have improved performance with the addition of our patented Roetech bacteria. These specialized bacteria are the same bacteria used in our professional formulations, and are used in municipal wastewater treatment facilities throughout the country.

We have formulated this next generation product as a concentrate. This allows for the delivery of more enzyme producing bacteria to the problem area. K-570 can prevent system failure and more rapidly breaks up drain field clogs to restore proper drainage. Concentrating the formulation also makes it more convenient for treating the larger septic systems found in today's homes.

AVAILABLE:
LEACH & DRAIN FIELD CONC. TREATMENTS
 Quart Concentrate - Treats 1500 Gallons

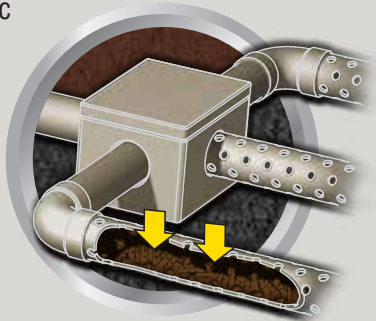

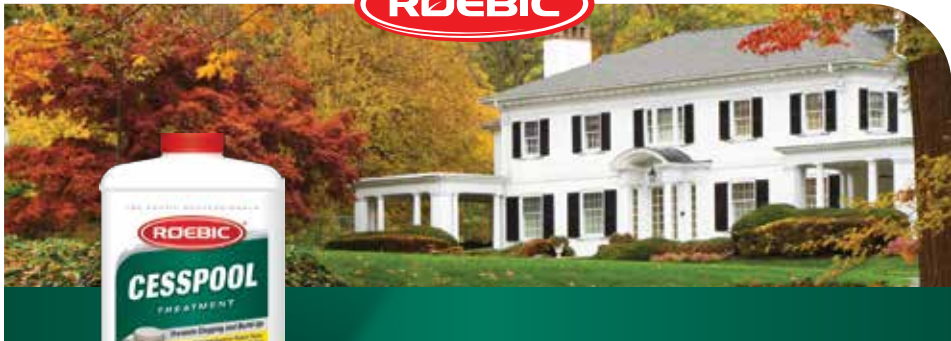

K-47 CESSPOOL TREATMENT

If your septic system has a cesspool, then the cesspool acts as the primary receiving area for all household waste. Therefore, cesspools tend to be burdened with the same types of demands and problems that are commonly seen in septic tanks. However, the working environment is not the same. K-47 Cesspool Treatment has been formulated to promote the efficient and rapid breakdown of solids, under the unique conditions found in a cesspool. Less solids will result in reduced odors, less clogs and more efficient system operation.

AVAILABLE:

CESSPOOL TREATMENT

Quart - Treats 500 Gallons



K-57 SEPTIC SYSTEM CLEANER FOR "EMERGENCY" SITUATIONS

K-57 Septic System Cleaner is a powerful biological product which is formulated with our patented bacterial cultures. K-57 is powerful enough to act quickly in emergency situations where sluggish conditions, clogs, surface water accumulations, or back-ups have occurred.

Over the last 50 years, K-57 has "seen it all" regarding septic system problems and has restored countless systems to useful working order. If your system is giving you trouble, get Roebic K-57 and get it done!

AVAILABLE:

SEPTIC SYSTEM CLEANERS

Quart - Treats 500 Gallons
Half Gallon - Treats 1000 Gallons

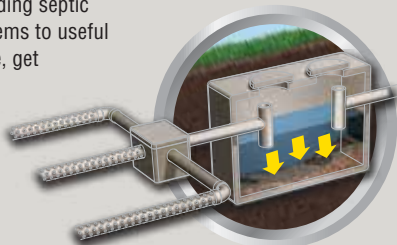



K-67 DRAIN & TRAP CLEANER

Organic debris can build-up in household drains and traps, which may lead to slow draining kitchen sinks, bathroom sinks and tubs. Left untreated this buildup will cause clogs and back-ups. Keep your drains and traps running freely with a regular application of K-67, a powerful non-corrosive and natural drain cleaning product.

AVAILABLE:

DRAIN & TRAP CLEANER

Quart

Granular Concentrate

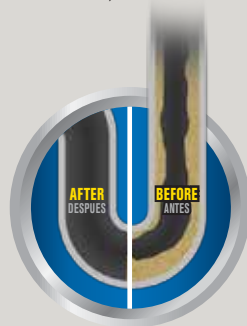

K-97 MAIN LINE CLEANER

Waste can accumulate in sewer lines and in main lines leading to septic tanks. This is a common problem in both old and newer homes, as modern water saving toilets do a poor job of pushing waste out of sewage lines. This troublesome organic build-up can quickly result in clogging problems and back-ups. Roebic's K-97 Main Line Cleaner attacks this accumulated material and quickly restores proper flow, keeping your lines problem free.

AVAILABLE:

MAIN LINE CLEANER

Quart

Half Gallon

Quart Concentrate

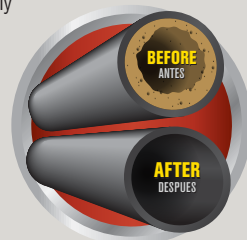



K-27 GARBAGE DISPOSAL CLEANER & DEODORIZER

Garbage disposals can become clogged with food particles resulting in sink line back-ups. These “stale” foods also create unpleasant odors throughout your entire kitchen area. K-27 Garbage Disposal Cleaner & Deodorizer is formulated to break down grease and other food particles trapped in your disposal. Regular use of K-27 will result in problem free and pleasant smelling drains.

AVAILABLE:

GARBAGE DISPOSAL CLEANER & DEODORIZER

Quart



K-87 SOAP, GREASE, & PAPER DIGESTER

S.G.P. is specially formulated to breakdown Soap, Grease and Paper. K-87 contains Roebic’s patented bacterial cultures, capable of degrading these difficult to breakdown products. Adding S.G.P. to your system will fortify your system’s bacteria and help ensure problem free septic system operations.

AVAILABLE:

SOAP, GREASE, & PAPER DIGESTER

- | | |
|-------------------|-----------------------|
| Quart | - Treats 500 Gallons |
| Quart Concentrate | - Treats 1500 Gallons |



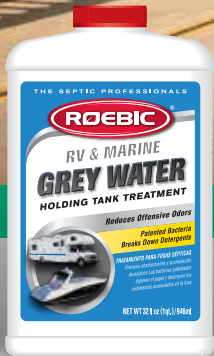

RV & MARINE BLACK WATER RV & MARINE GREY WATER

Roebic's RV and Marine products contain specialized bacteria engineered for the smaller holding tanks typically found in motor homes and boats. In Black Water tanks the fast acting and fast multiplying bacteria quickly break down solid waste. In the Grey Water application, the bacteria start to breakdown soap, grease and food particles. Both treatments are biodegradable, will not harm the environment and work extremely well at controlling odors.

AVAILABLE:

RV & MARINE BLACK WATER

Quart

RV & MARINE GREY WATER

Quart



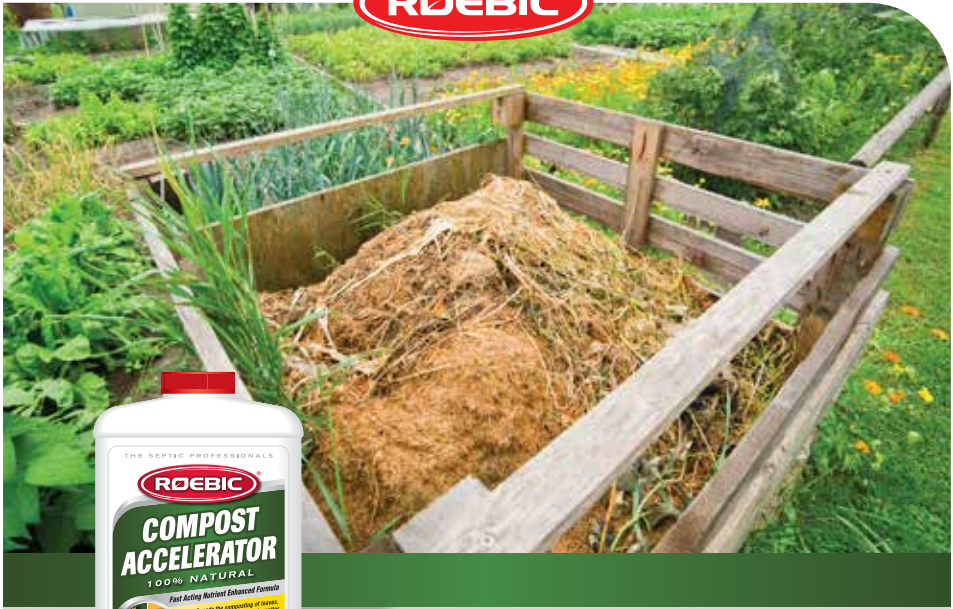

COMPOST ACCELERATOR

ROEBIC COMPOST ACCELERATOR is a blend of specialized bacteria, which accelerates the breakdown of plant material in compost piles. ACCELERATOR works on green or dry grass clippings, weeds, leaves, shrub trimmings and vegetable scraps and peelings.



AVAILABLE:

COMPOST ACCELERATOR

2.5 lbs.

Green Solutions

Roebic is committed to the environment. Our bacterial based formulations, including composting and recreational products, are 100% natural and biodegradable. These formulations are safe for all environments.





K-77 ROOT KILLER FOAMING ROOT KILLER

When roots invade sewer pipes and clog septic system drain fields, Roebic's fast acting root killing formulas are needed. Foaming Root Killer destroys roots that find their way into in a home's sewer line, which can cause costly backups. K-77 clears roots from leach fields, improving drainage and flow. This can prevent standing water and soggy conditions from developing over a leach field. NOT AVAILABLE FOR EXPORT.

AVAILABLE:

ROOT KILLER 2 lbs.

(Not available in Connecticut and the Bay Counties of California.
Banned for use in septic systems in Florida and Massachusetts.)

FOAMING ROOT KILLER 1 lbs.

(Banned for use in septic systems in Florida.)

Tough Solutions

Our root killers and drain openers are formulated to take on the toughest of jobs, fast. When problems come up that need fast acting solutions Roebic root killer and drain openers work quickly to clear the problem. For long term biological solutions follow up with Roebic K series products. These products will restore the natural balance to your household wastewater system.





PROFESSIONAL STRENGTH LIQUID DRAIN OPENER

Now available for home use, Roebic Professional Strength Liquid Drain Opener clears the tough clogs fast, even through standing water. It's safe for plumbing fixtures and plastic pipes. Not for use in aluminium sinks, garbage disposals, lead traps or toilets. NOT AVAILABLE FOR EXPORT.

AVAILABLE:
LIQUID DRAIN OPENER

- Quart
- Half Gallon



PROFESSIONAL STRENGTH CRYSTAL DRAIN OPENER

Professional Strength Crystal Drain Opener clears tough clogs from pipes, destroys grease and will keep drains clear. Professional Strength Crystal Drain Opener contains 100% LYE (sodium hydroxide, caustic soda). Not for use in toilets, garbage disposals or with aluminium, lead, zinc or galvanized pipes. NOT AVAILABLE FOR EXPORT.

AVAILABLE:
CRYSTAL DRAIN OPENER 2 lbs.

Contacts

Orders/Information:

Roebic Laboratories, Inc.
25 Connair Road, P.O. Box 927
Orange, CT 06477 USA

phone: **203.795.1283**
fax: 203.795.5227
e-mail: **orders@roebic.com**
website: www.roebic.com

Technical Information

Steven H. Smith
VP Product Development /
Microbiologist

Roebic Laboratories, Inc.
25 Connair Road, P.O. Box 927
Orange, CT 06477 USA
phone: **203.795.1283**
fax: 203.795.5227
e-mail: **steves@roebic.com**

Domestic Sales:

Craig R. Brewer
Vice President, Sales & Marketing

8280 Courtney Drive
Fishers, IN 46038 USA
phone: **317.578.0135**
cell: **317.698.8866**
fax: 317.578.0136
e-mail: **craigb@roebic.com**

International Sales:

John M. Peters
Vice President Global Sales
Roebic International, Inc

1213 Ocean Dunes Circle
Jupiter, FL 33477 USA
phone: **561.799.3380**
fax: 561.799.3402
e-mail: **johnp@roebic.com**

©2016 Roebic Laboratories, Inc.

